

Article number: 0102021

Description: Retaining ring J8 DIN472  
Spring steel

## Measures

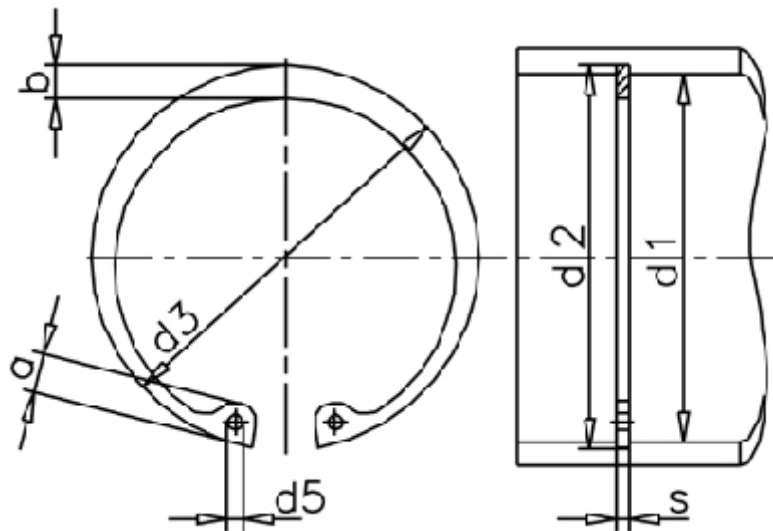

a max	= 2.4	FN kN	= 0.86	t	= 0.20
AN mm <sup>2</sup>	= 5.1	FRg kN	= 1.5	tol	= +0,09
b	= 1.1	FR kN	= 2.0	tol	= +0,36-1,10
d1	= 8	g	= 0.5	tol	= -0.05
d2	= 8.4	K kN-mm	= 9.2	Tong	= ZGJ-0
d3	= 8.70	m min	= 0.90	Weight kg/1000	= 0.10
d5 min	= 1.0	Nominal drive	= 0.6		
Description = J 8		s	= 0.80		